

**IMPAC Pyrometer**  
IGA 6/23 Advanced

MANUAL



## Confidential Information

The material contained herein consists of information that is the property of LumaSense Technologies and intended solely for use by the purchaser of the equipment described in this manual. All specifications are subject to change without notice. Changes are made periodically to the information in this publication, and these changes will be incorporated in new editions.

LumaSense Technologies prohibits the duplication of any portion of this manual or the use thereof for any purpose other than the operation or maintenance of the equipment described in this manual, without the express written permission of LumaSense Technologies.

## Copyright

© LumaSense Technologies 2018. All rights reserved.

## Trademarks

IMPAC is a trademark of LumaSense Technologies.

All other trademarks are trademarks, registered trademarks, and/or service marks of their respective holders.

## Service Centers

### LumaSense Technologies, Inc.

#### North America

#### Sales & Service

Santa Clara, CA, USA

Ph: +1 800 631 0176

Ph: +1 408 727 1600

Fax: +1 408 727 1677

### LumaSense Technologies GmbH

#### Other Than North America

#### Sales & Support

Frankfurt, Germany

Ph: +49 (0) 69 97373 0

Fax: +49 (0) 69 97373 167

## Global and Regional Centers

### Our Headquarters

LumaSense Technologies, Inc.

Santa Clara, CA, USA

Ph: +1 800 631 0176

Fax: +1 408 727 1677

### Americas, Australia, & Other Asia

LumaSense Technologies, Inc.

Santa Clara, CA, USA

Ph: +1 800 631 0176

Fax: +1 408 727 1677

### Europe, Middle East, Africa

LumaSense Technologies GmbH

Frankfurt, Germany

Ph: +49 (0) 69 97373 0

Fax: +49 (0) 69 97373 167

### Frankreich

Sales & Support Center

Erstein, Frankreich

Telefon: +33 3 8898 9801

Fax: +33 3 8898 9732

### India

LumaSense Technologies, India

Mumbai, India

Ph: + 91 22 67419203

Fax: + 91 22 67419201

### China

LumaSense Technologies, China

Shanghai, China

Ph: +86 133 1182 7766

Fax: +86 21 5877 2383

## E-mail

info@lumasenseinc.com

support@lumasenseinc.com

eusupport@lumasenseinc.com

## Website

<http://www.lumasenseinc.com>

Part No 3 904 226 - EN

Revision B

March 2018

---

# Contents

<b>1</b>	<b>General Information</b>	<b>5</b>
1.1	Information about the user manual	5
1.1.1	Legend	5
1.1.2	Terminology	5
1.2	Safety	5
1.3	Limit of liability and warranty	6
1.4	Unpacking the Instrument	6
1.5	Service Request, Repair, or Support	6
1.6	Shipments to LumaSense for Repair	7
1.7	Transport, Packing, Storage	7
1.8	Disposal / decommissioning	7
<b>2</b>	<b>Introduction</b>	<b>9</b>
2.1	Appropriate use	9
2.2	Scope of delivery	9
2.3	Technical Data	9
2.4	Dimensions	11
2.5	Physical User Interface	11
2.6	Accessories (Optional)	12
2.6.1	Mounting	12
2.6.2	Cooling Jacket	12
2.6.3	Air Purge	12
2.6.4	Vacuum Pickup	12
2.6.5	Scanning Mirror	12
2.6.6	Flange System	13
<b>3</b>	<b>Controls and Installation</b>	<b>15</b>
3.1	Electrical Installation	15
3.1.1	Pin assignment of the connector	16
3.1.2	Connecting the pyrometer to a PC	17
3.1.3	Connection to RS485	17
3.1.4	Connection of Additional Units	18
3.2	Sighting	18
3.2.1	Viewfinder	18
3.2.2	Laser Targeting Light	19
3.3	Optics	20
3.3.1	Spot Sizes	20
3.3.2	Deviation from the focused measuring distance	21
3.3.3	Finding the right measuring distance	22
<b>4</b>	<b>Settings / parameter descriptions</b>	<b>25</b>
4.1	Factory Settings	25
4.2	Temperature Display	25
4.3	Emissivity $\varepsilon$	25
4.4	Transmittance $\tau$	26
4.5	Response Time ( $t_{90}$ )	26

<b>4.6</b>	<b>Clear Peak Memory (t<sub>CLEAR</sub>)</b> .....	<b>27</b>
4.6.1	Single and Double Storage Modes .....	27
4.6.2	Clear Time Settings .....	28
<b>4.7</b>	<b>Analog Output</b> .....	<b>28</b>
<b>4.8</b>	<b>Sub Range</b> .....	<b>28</b>
<b>4.9</b>	<b>Device Address</b> .....	<b>29</b>
<b>4.10</b>	<b>Focused Distance</b> .....	<b>29</b>
<b>4.11</b>	<b>Baud Rate</b> .....	<b>29</b>
<b>4.12</b>	<b>Pyrometer Internal Temperature</b> .....	<b>30</b>
<b>4.13</b>	<b>Ambient Temperature Compensation</b> .....	<b>30</b>
<b>5</b>	<b>Software InfraWin</b> .....	<b>31</b>
<b>5.1</b>	<b>Connecting the pyrometer to a PC</b> .....	<b>31</b>
<b>5.2</b>	<b>Installation</b> .....	<b>31</b>
<b>5.3</b>	<b>Program start</b> .....	<b>31</b>
<b>6</b>	<b>Maintenance</b> .....	<b>33</b>
<b>6.1</b>	<b>Cleaning the front window</b> .....	<b>33</b>
<b>6.2</b>	<b>Calibration</b> .....	<b>33</b>
6.2.1	Laboratory Calibration .....	33
6.2.2	On-Site Calibration .....	34
<b>7</b>	<b>Data format UPP (Universal Pyrometer Protocol)</b> .....	<b>35</b>
<b>8</b>	<b>Reference Numbers</b> .....	<b>39</b>
<b>8.1</b>	<b>Reference numbers instrument</b> .....	<b>39</b>
<b>8.2</b>	<b>Reference numbers accessories</b> .....	<b>39</b>
<b>9</b>	<b>Troubleshooting</b> .....	<b>41</b>
	<b>Index</b> .....	<b>45</b>

---

# 1 General Information

## 1.1 Information about the user manual

Congratulations on choosing the high quality and highly efficient IMPAC IGA 6/23 Advanced pyrometer.

This manual provides important information about the instrument and can be used as a work of reference for installing, operating, and maintaining your IGA 6/23 Advanced pyrometer. It is important that you carefully read the information contained in this manual and follow all safety procedures before you install or operate the instrument.

To avoid handling errors, keep this manual in a location where it will be readily accessible.

### 1.1.1 Legend



**Note:** The note symbol indicates tips and useful information in this manual. All notes should be read to effectively operate the instrument.



**Attention:** This sign indicates special information which is necessary for a correct temperature measurement.



**Warnings and Cautions:** The general warnings and cautions symbol signifies the potential for bodily harm or damage to equipment.

---

**MB**

Shortcut for Temperature range (in German: **Messbereich**)

---

### 1.1.2 Terminology

The terminology used in this manual corresponds to the VDI- / VDE-directives 3511, Part 4.

## 1.2 Safety

This manual provides important information on safely installing and operating the IGA 6/23 Advanced pyrometer. Several sections of this manual provide safety warnings to avert danger. These safety warnings are specified with a warning symbol. You must read and understand the contents of this manual before operating the instrument even if you have used similar instruments or have already been trained by the manufacturer.

It is also important to continually pay attention to all labels and markings on the instrument and to keep the labels and markings in a permanent readable condition.



**Warning:** The pyrometer is only to be used as described in this manual. It is recommended that you only use accessories provided by the manufacturer.

---

In addition, signs and markings on the device is to be observed and maintained in legible condition.

### 1.3 Limit of liability and warranty

All general information and notes for handling, maintenance, and cleaning of this instrument are offered according to the best of our knowledge and experience.

LumaSense Technologies is not liable for any damages that arise from the use of any examples or processes mentioned in this manual or in case the content of this document should be incomplete or incorrect. LumaSense Technologies reserves the right to revise this document and to make changes from time to time in the content hereof without obligation to notify any person or persons of such revisions or changes.

All instruments from LumaSense Technologies have a regionally effective warranty period. Please check our website at <http://info.lumasenseinc.com/warranty> for up-to-date warranty information. This warranty covers manufacturing defects and faults which arise during operation, only if they are the result of defects caused by LumaSense Technologies.

The *Windows compatible software* was thoroughly tested on a wide range of Windows operating systems and in several world languages. Nevertheless, there is always a possibility that a Windows or PC configuration or some other unforeseen condition exists that would cause the software not to run smoothly. The manufacturer assumes no responsibility or liability and will not guarantee the performance of the software. Liability regarding any direct or indirect damage caused by this software is excluded.

The warranty is VOID if the instrument is disassembled, tampered with, altered, or otherwise damaged without prior written consent from LumaSense Technologies; or if considered by LumaSense Technologies to be abused or used in abnormal conditions.

There are no user-serviceable components in the instrument:

- No adjustments may be made to the targeting laser. It is fixed at the factory.
- No adjustments may be made to the targeting laser's power level.

### 1.4 Unpacking the Instrument

Thoroughly inspect the instrument upon delivery to purchaser. Check all materials in the container against the enclosed packing list. LumaSense Technologies cannot be responsible for shortages against the packing list unless a claim is immediately filed with the carrier. Final claim and negotiations with the carrier must be completed by the customer.

Save all packing materials, including the carrier's identification codes, until you have inspected the pyrometer and find that there is no obvious or hidden damage. Before shipment, the pyrometer was examined and has been tested. If you note any damage or suspect damage, immediately contact the carrier and LumaSense Technologies, Inc.

### 1.5 Service Request, Repair, or Support

Contact LumaSense Technologies Technical Support in case of a malfunction or service request. Provide clearly stated details of the problem as well as the instrument model number and serial number. Upon receipt of this information, Technical Support will attempt to locate the fault and, if possible, solve the problem over the telephone.

If Technical Support concludes that the instrument must be returned to LumaSense Technologies for repair, they will issue a Return Material Authorization (RMA) number.

Return the instrument upon receipt of the RMA number, transportation prepaid. Clearly indicate the assigned RMA number on the shipping package exterior. Refer to Section 1.6, Shipments to LumaSense for Repair, for shipping instructions.

Technical Support can be contacted by telephone or email:

**Santa Clara, California**

- Telephone: +1 408 727 1600 or +1 800 631 0176
- Email: support@lumasenseinc.com

**Frankfurt, Germany**

- Telephone: +49 (0) 69 97373 0
- Email: support@lumasenseinc.com

**Erstein, France**

- Telephone +33 (0)3 88 98 98 01
- Email support@lumasenseinc.com

## 1.6 Shipments to LumaSense for Repair

All RMA shipments of LumaSense Technologies instruments are to be prepaid and insured by way of United Parcel Service (UPS) or preferred choice. For overseas customers, ship units air-freight, priority one.

The instrument must be shipped in the original packing container or its equivalent. LumaSense Technologies is not responsible for freight damage to instruments that are improperly packed.

Contact us to obtain an RMA number (if Technical Support has not already assigned one). Clearly indicate the assigned RMA number on the shipping package exterior.

Send RMA Shipments to your nearest technical service center:

**Santa Clara, California**

LumaSense Technologies, Inc.  
3301 Leonard Court  
Santa Clara, CA 95054 USA  
Telephone: +1 408 727 1600  
                  +1 800 631 0176

**Email:** support@lumasenseinc.com

**Frankfurt, Germany**

LumaSense Technologies GmbH  
Kleyerstr. 90  
60326 Frankfurt  
Germany  
Telephone: +49 (0)69-97373 0

**Email:** support@lumasenseinc.com

## 1.7 Transport, Packing, Storage

With faulty shipping, the instrument can be damaged or destroyed. To transport or store the instrument, please use the original box or a box padded with sufficient shock-absorbing material. For storage in humid areas or shipment overseas, the device should be placed in welded foil (ideally along with silica gel) to protect it from humidity.

The pyrometer is designed for a storage temperature of -20 to 80 °C with non-condensing conditions. Storing the instrument out of these conditions can cause damage or result in malfunction of the pyrometer.

## 1.8 Disposal / decommissioning

Inoperable instruments must be disposed of in compliance with local regulations for electronic materials.

To ensure consistent document formatting, this page was intentionally left blank.

## 2 Introduction

### 2.1 Appropriate use

The IMPAC IGA 6/23 is a short wave infrared temperature measuring device with digital signal processing. It is used for non-contact temperature measurements on metals, ceramics, graphite, etc. with a temperature range between 50 and 1800 °C.

### 2.2 Scope of delivery

Pyrometer, PC adjustment, and evaluation software *InfraWin*, works certificate, and operating instructions.



**Note:** A connection cable is not included with the instrument and has to be ordered separately (see Chapter 8, **Reference numbers**).

### 2.3 Technical Data

#### Measurement

Temperature Ranges:	50 to 1000 °C (MB 10) 75 to 1300 °C (MB 13) 150 to 1800 °C (MB 18)		
Sub Range:	Any range adjustable within the temperature range, minimum span 50 °C		
Spectral Ranges:	2 to 2.6 µm (main wavelength 2.3 µm)		
Resolution:	0.1 °C or 0.2 °F at interface; < 0.0015% of adjusted temperature range at analog output, 16 bit; 1 °C or 1 °F on display		
Emissivity ε:	0.050 to 1.000 in steps of 1/1000		
Transmittance τ:	0.050 to 1.000 in steps of 1/1000		
Response Time t <sub>90</sub> :	0.5 ms (with dynamic adaptation at low signal levels) adjustable to min; 1 ms; 3 ms; 5 ms; 10 ms; 50 ms; 250 ms; 1 s; 3 s; 10 s		
Measurement Uncertainty: (ε = 1, t <sub>90</sub> = 1 s, T <sub>Umg.</sub> = 25 °C)	< 1500 °C: 0.3% of reading in °C + 2 °C > 1500 °C: 0.6% of reading in °C		
Repeatability: (ε = 1, t <sub>90</sub> = 1 s, T <sub>Umg.</sub> = 25 °C)	0.15% of reading in °C + 1 °C		
Noise Equivalent Temperature Difference (NETD): (ε = 1, σ = 1, T <sub>Umg.</sub> = 25 °C, t <sub>90</sub> = min)		<b>Temperature / °C</b>	<b>NETD</b>
	MB 10	60	0.9
		100	0.5
		150	0.1
	MB 13	100	1.2
		200	0.6
		250	0.1
	MB 18	200	1.5
		300	0.6
		400	0.2

## Optics

Sighting:		Built-in laser aiming light (max. power level < 1 mW, $\lambda = 630$ to 680 nm, CDRH class II) or through-lens sighting
Optics:		Manually focusable from rear cover measuring distance $a = 210$ to 5000 mm
Distance Ratio:		MB 10: approx. 50 : 1 MB 13: approx. 100 : 1 MB 18: approx. 350 : 1

## Environment

Protection Class:	IP 65 IEC 60529 (value in mated condition)
Operating Position:	Any
Ambient Temperature:	0 to 70 °C at housing
Storage Temperature:	-20 to 80 °C
Relative Humidity:	Non condensating conditions
Weight:	0.6 kg
Housing:	Stainless steel
CE-Label:	According to EU directives about electromagnetic immunity

## Interface

Connection:	12-pin connector
Display (in rear cover):	LED, 4 digit matrix, 5 mm high temperature signal or measuring distance
Parameters:	Adjustable via interface: emissivity, sub range, ambient temperature compensation, wait time $t_w$ , settings for maximum value storage, address, baud rate, transmittance, response time $t_{90}$ , 0 to 20 mA or 4 to 20 mA analog output range, °C/°F  Readable via interface: measured value, internal temperature of the unit, measuring distance

## Communication

Analog Output:	Adjustable 0 to 20 mA or 4 to 20 mA, linear (via digital interface)
Digital Interface:	RS485 addressable (half-duplex) Baud rate: 1200 Bd to 115.2 kBd or RS232
Maximum Value Storage:	Built-in single or double storage. Clearing with adjusted time $t_{clear}$ (off; 10 ms; 50 ms; 250 ms; 1 s; 5 s; 25 s), via interface, automatically with the next measuring object, hold-function

## Electrical

Power Supply:	24 V DC $\pm$ 25%, ripple must be less than 50 mV
Power Consumption:	Max. 3 W (incl. laser)
Load (analog output):	0 to 500 Ohm
Isolation:	Power supply, analog output, and digital interface are galvanically isolated from each other



**Note:** The calibration / adjustment of the instruments was carried out in accordance with VDI/VDE directive "Temperature measurement in industry, Radiation thermometry, Calibration of radiation thermometers", VDI/VDE 3511, Part 4.4. For additional details on this directive, see <http://info.lumasenseinc.com/calibration> or order the directive from "Beuth Verlag GmbH" in D-10772 Berlin, Germany.

## 2.4 Dimensions

IGA 6/23 Advanced with the view finder

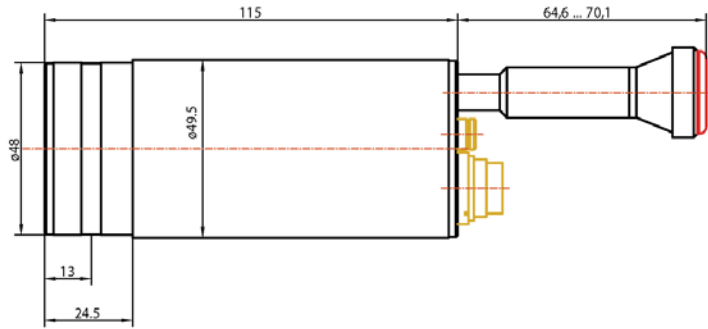

IGA 6/23 Advanced with laser sighting

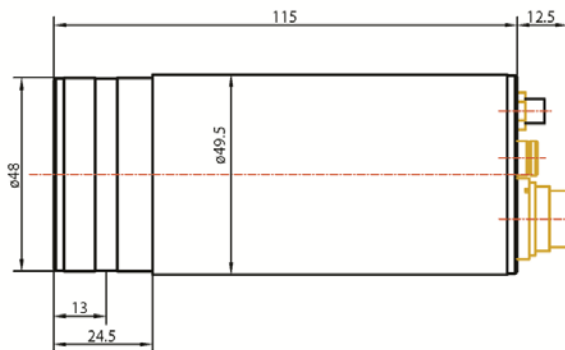

## 2.5 Physical User Interface



IGA 6/23 Advanced with laser sighting



IGA 6/23 Advanced with the view finder

- 1 12-pin connector
- 2 Digital display
- 3 Optional sighting
- 4 Screw to adjust the focus
- 5 LED distance display
- 6 LED indicator light
- 7 Adjusting for the view finder



**Warning:** If selected, the IGA 6/23 Advanced laser light option is a Class 2 and emits laser light.

To minimize the risk of eye injury, do not look directly into the beam, and do not point the laser beam of the pilot light into the eyes of another person.



## 2.6 Accessories (Optional)

Numerous accessories guarantee easy installation of the pyrometer. The following overview shows a selection of suitable accessories. You can find the entire accessory program with all reference numbers in Chapter [8, Reference numbers](#).

### 2.6.1 Mounting

Mounting brackets are available for safe mounting and alignment of the pyrometer to the measuring object.



Mounting angle

### 2.6.2 Cooling Jacket

The stainless steel housing with integrated water-cooling air purge allows use of the pyrometer above the maximum permissible ambient temperature. The pyrometer can be operated in ambient temperatures up to 180 °C.



Water cooling jacket with integrated air purge

### 2.6.3 Air Purge

The air purge protects the lens from contamination of dust and moisture. It has to be supplied with dry and oil-free pressurized air and generates an air stream shaped like a cone.



Air purge

### 2.6.4 Vacuum Pickup

The vacuum pickup KF16 with window allows the user to easily mount the pyrometer on vacuum systems.



Vacuum Pickup

### 2.6.5 Scanning Mirror

The scanning mirror unit SCA 5 allows the measured object to be scanned over a certain range. The measuring beam of the pyrometer moves straight in one line across the object and collects temperature data of this line. This is useful when used in combination with the maximum value storage (peak picker) to measure objects, which move out of the target area. The scanning angle of the mirror is 0 to 12° and the scanning frequency 0 to 5 Hz. Both values are easily adjustable at the scanner.



Scanning Mirror

## 2.6.6 Flange System

The flange system is a modular mounting system to fix the pyrometer on furnaces, vacuum chambers, etc.

It can consist of e.g. mounting support, tube support with air purge and flange and an open or closed ceramic sighting tube. The mounting support can be equipped with a quartz window for vacuum applications. It may consist of an equipment rack, flange, and an open or closed ceramic tube. The equipment rack can be equipped for vacuum applications with a fused silica.

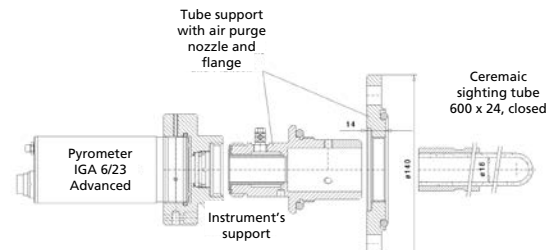

*Schematic drawing of the flange system*

To ensure consistent document formatting, this page was intentionally left blank.

---

## 3 Controls and Installation

### 3.1 Electrical Installation

The IGA 6/23 Advanced is powered by a voltage of 24 V DC  $\pm$  25% (ripple < 50 mV). It is important to ensure correct polarity when connecting the device to the power supply. The length of the 24 V supply line should not be longer than 30 m. Hence, the use of 24 V site internal supply network is also not recommended. This length restriction does not apply for the analog and digital signal lines.

To meet the electromagnetic requirements (EMV), a shielded connecting cable must be used. LumaSense offers connecting cables, which are not part of the standard scope of delivery. The shield of the connecting cable has to be connected only on the pyrometer's side. If the connecting cable is extended, the shield of the extension also needs to be extended. The shield must be open on the power supply side (switch board), to avoid ground loops.

The connecting cable has wires for the power supply, interface, analog output, switch contact, and external clearing of the maximum value storage via contact and 12-pin connector (see Chapter [8](#), **Reference numbers**).



**Attention:** When connecting the power supply, ensure the polarity is correct.

---

Once the instrument has been connected to the power supply, it is immediately ready for use. Although it does not need to be warmed up, it does need to run for approximately 15 to 30 minutes before achieving full accuracy. The instrument can be switched off by interrupting the power supply or unplugging the electrical connector.

### 3.1.1 Pin assignment of the connector

Pin	Color	Function
K	white	+24 V DC power supply
A	brown	0 V DC power supply
L	green	+ I <sub>Ausg.</sub> analog output
B	yellow	- I <sub>Ausg.</sub> analog output
H	gray	Targeting light activate / deactivate via external switch (bridged with K)
J	pink	External clearing of max. value storage (bridge to K) or hold function*
G	red	DGND (GND for interface)
F	black	B1 (RS485) or RxD (RS232)
C	violet	A1 (RS485) or TxD (RS232)
D	gray-pink	B2 (RS485) (bridged with F)
E	red-blue	A2 (RS485) (bridged with C)
M	orange	Screen only for cable extension, don't connect at the switchboard

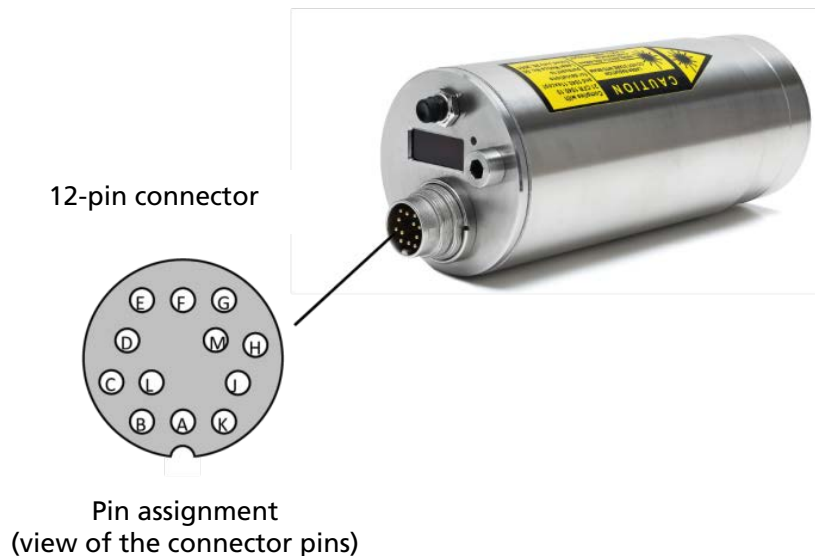

\*The connector pin J can be used for two different functions:

1. **External clearing of the maximum value storage:** When the pyrometer is in operating mode, pin J can be used for external clearing of maximum value storage. When external clearing is selected from the tclear dropdown menu, pin J is connected for a short time to pin K (power supply voltage) to clear the stored maximum value. The function "external clearing" is triggered when the clear time is set to "extern".
2. **Hold function:** When the hold function mode is activated, the current temperature reading is frozen as long as pin J and pin K are connected. (See section 4.6 for clear time for the maximum value storage).

### 3.1.2 Connecting the pyrometer to a PC

The pyrometer is equipped with an RS485 serial interface. With the RS485, long transmission distances can be realized and the transmission is, to a large extent, free of problems. The RS485 also allows several pyrometers to be connected in a bus system.

If an RS485 connection is not available at the PC, it can be accomplished using the RS485 to USB connector. When using a RS485 to USB adapter, make sure that the adapter is fast enough to receive the pyrometer's answer to an instruction of the master. Most of the commonly used adapters are too slow for fast measuring equipment, so it is recommended to use the RS485 ↔ USB converter "USB nano" (ref. no. 3 852 600).

### 3.1.3 Connection to RS485

Half-duplex mode: A1 and A2 as well as B1 and B2 are bridged in the 12-pin round connector of the connecting cable, to prevent reflections due to long stubs. It also safeguards against the interruption of the RS485 bus system, should a connecting plug be pulled out. The master labels mark the connections on the RS485 converter.

The transmission rate of the serial interface in Baud (Bd) is dependent on the length of the cable. Adjusted values are from 1200 to 115200 Bd.

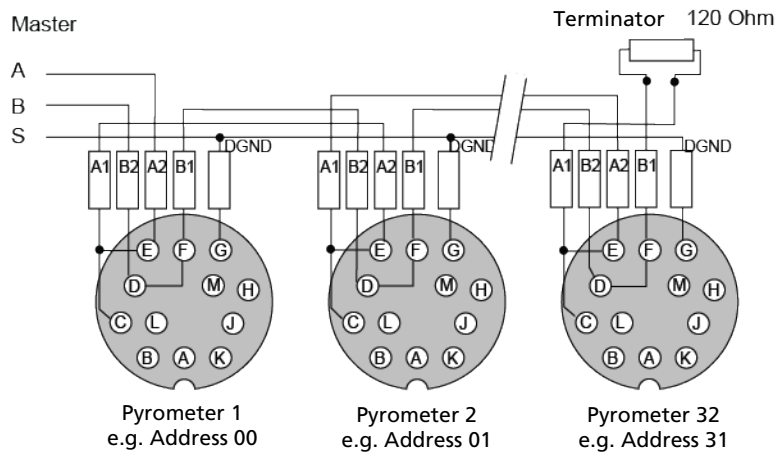

*RS485 Bus System*

### 3.1.4 Connection of Additional Units

For temperature indication of the pyrometer, LumaSense offers pure indicators (series DA 4000). LumaSense also offers indicators with features to change pyrometer parameters (DA 6000 and DA 6000-N) as well as a fast digital PID controller PI 6000.



Digital Display



Parameterizing Indicator



Digital Controller

Additional analyzing instruments, including LED digital displays only need to be connected to a power supply and the analog outputs of the pyrometer (exception: the digital display DA 6000 can also be connected with its serial interface, whereas the digital display DA 6000-N has to be connected with its serial interface).

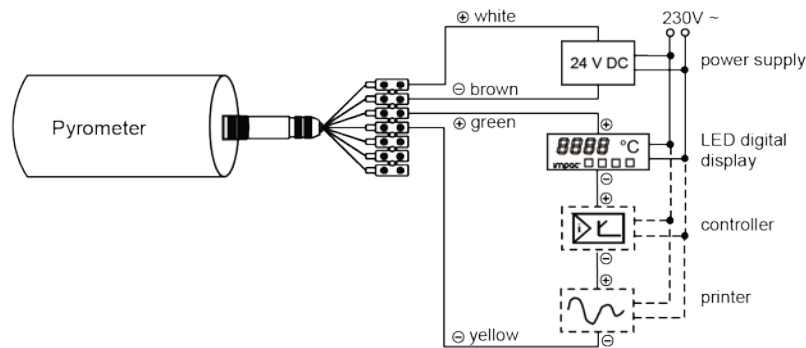

Connection of additional units

Other instruments like an analog controller or printer can be connected to the display in a series as shown above (total load of resistance max. 500 Ohm).

## 3.2 Sighting

The IGA 6/23 Advanced can be purchased with Through-Lens Sighting (viewfinder) or with a Laser Targeting Light. These sighting options allow you to easily align the pyrometer to the measuring object.

### 3.2.1 Viewfinder

The IGA 6/23 Advanced can be equipped with a viewfinder which offers through-lens sighting. The viewfinder is true-sided and parallax-free. A circle marks the position of the measuring spot, but not the exact spot size.

The viewfinder is equipped with an adjustable eye-protection filter, which allows you to view hot objects without exposing your eye to high intensity light. When you are viewing hot objects, turn the adjustment ring on the viewfinder so the filter will let in less light.



**Warning:** To ensure eye protection, make sure you use the shaded filter when viewing objects with temperatures of 1500 °C or higher.



Viewfinder Adjustment Ring



**Note:** You can turn the adjustment ring on the viewfinder in both a clockwise and counterclockwise direction to change the filter from light to dark.

When you are viewing low temperature objects, turn the viewfinder adjustment ring so the filter will let in more light.

### 3.2.2 Laser Targeting Light

The IGA 6/23 Advanced can be equipped with a laser targeting light to assist with aligning the pyrometer to the measuring object. The laser targeting light is a visible red light with a wavelength between 630 and 680 nm and a maximum power of 1 mW. The laser is classified as product of laser class II.

The laser spot marks the center of the measuring spot on the target. The diameter does not correspond to the spot size. The smallest diameter of the laser spot approximately indicates the measuring distance.



**Warning:** The instrument is equipped with a class II laser that emits radiation.

To reduce the risk of injury to the eyes, do not look directly into the targeting laser and do not point the targeting laser into anyone's eyes.

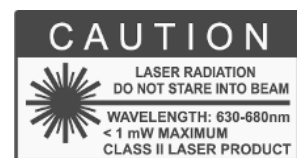

Never look directly into the laser beam. The beam and spot can be watched safely from side. Also, make sure that the beam will not be reflected into eyes of people by mirrors or shiny surfaces.

The laser targeting light can be switched on and off by pressing the button of the rear cover of the housing.



Push button for  
Laser Targeting Light



**Note:** The laser warning signs on the pyrometer should be easily viewable at all times, even after it has been installed.

---

The laser targeting light can also be switched on and off by using an external contact (see section 3.1.1 Pin Assignment) or through the InfraWin software. If it is not switched off by one of the above-mentioned methods, it will be switched off automatically after approximately 2 minutes.

To prevent damage to the laser, the targeting light is also switched off automatically if the internal temperature of the pyrometer exceeds 61 °C. It can only be used again once the temperature falls below 61 °C.

## 3.3 Optics

### 3.3.1 Spot Sizes

The IGA 6/23 Advanced has a Vario optics, which can be manually adjusted at all distances between 210 mm and 5000 mm.

The table of Spot Sizes in Relation to Measuring Distance shows examples of the pyrometer's spot size  $M$  [mm] in relation to the measuring distance  $a$  [mm] (min. 90% of the radiation intensity). Increasing or decreasing the measuring distance will change the spot size.

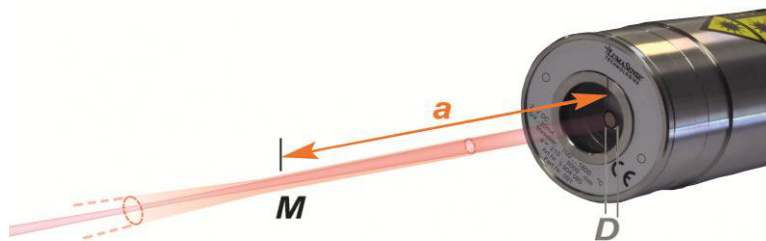

**Note:** Since these are 1-color (mono) pyrometers, they can measure objects at any distance (whether focused or non-focused). However, the object has to be bigger than, or at least as big as, the spot size of the pyrometer in the measuring distance.

---

Aperture D for all temperature ranges is 13 to 15 mm with the aperture being the effective diameter of the lens. This is dependent on the optical setting. The largest value applies to a very small measuring distance, while the minimum value applies to the largest measuring distance.

Measuring Distance a [mm]	Spot Diameter M [mm] MB 10	Spot Diameter M [mm] MB 13	Spot Diameter M [mm] MB 18
210	4.2	2.1	0.6
300	6	3	0.9
500	10	5	1.5
800	16	8	2.3
1300	26	13	3.7
2000	40	20	5.8
5000	100	50	15

*Examples of Spot Sizes in Relation to Measuring Distance*



**Note:** Effective aperture D for all temperature ranges is 13 mm (focused to longest distance) to 15 mm (focused to shortest distance).

Focused spot sizes between the listed distances can be found by linear interpolation between the listed values.

### 3.3.2 Deviation from the focused measuring distance

Spot sizes for non-focused distances (shorter or longer than the focused distance) may be calculated by using the formula below.

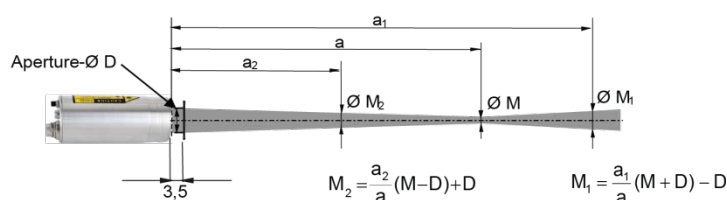

*Formula for Calculating Spot Sizes*

The InfraWin software also includes a Spot Size Calculator that calculates the data for the non-focused regions, if you enter the values of aperture D, focused measurement distance a, and focused measuring field diameter M as found in the above table (see section 3.3.1).

### 3.3.3 Finding the right measuring distance

The measuring distance can be set using the Focus Adjustment Screw on the back of the device. The focused distance value can be adjusted at all distances between 210 mm and 5000 mm. To focus, turn the focus adjustment set screw to make the target image appear sharp and clear.



**Note:** The optics are manually focusable with a measuring distance of a = 210 to 5000 mm.

---



The LED Distance Indicator Light (labeled mm) will turn red and the approximate focused measuring distance in mm will automatically be shown on the Digital Display for a few seconds after making an adjustment using the Focus Adjustment Set Screw.



**Note:** Turning the focus adjustment screw counterclockwise will shorten the measuring distance.

Turning the focus adjustment screw clockwise will lengthen the measuring distance.

---

To ensure consistent document formatting, this page was intentionally left blank.



---

## 4 Settings / parameter descriptions

The pyrometer is equipped with a wide range of settings for optimal adaptation to the required measuring condition and to measure the temperature correctly.



All settings can be read and set only in the **pyrometer parameters** window of the software *InfraWin*. Adjusting the settings at the instrument is not possible (detailed description of the software see Chapter [5](#), **Software *InfraWin***).

Selecting the pyrometer parameters window shows the current settings of the pyrometer. Changing a value can either be done by typing a value in an input box or by selecting a preset value from the list field.

### 4.1 Factory Settings

Temperature display ( $^{\circ}\text{C}$  /  $^{\circ}\text{F}$ ) =  $^{\circ}\text{C}$

Emissivity ( $\varepsilon$ ) = 100%

Transmittance ( $W$ ) = 100%

Exposure time ( $t_{90}$ ) = min

Dynamical adaptation  $dm$  = 4

Clear time ( $t_{\text{clear}}$ ) = off

max / min = maximum value storage preset

Analog output (out) = 0 ... 20 mA

Sub range same as basic temperature range

Ambient temperature compensation = auto

Address = 00

Baud rate = 19200 Bd

### 4.2 Temperature Display

The Digital Display on the back of the pyrometer will show the temperature measurement in either  $^{\circ}\text{C}$  or  $^{\circ}\text{F}$ . You can select which temperature scale you wish to use through the *InfraWin* software or by using the UPP Data Format commands.

The Measuring Value can also be viewed at any time through the *InfraWin* Software or by using the UPP Data Format commands.

### 4.3 Emissivity $\varepsilon$

Different materials have different emissivities ranging between 0% and 100%. The emissivity is also dependent upon on the surface condition of the material, the spectral range of the pyrometer, and the measuring temperature. The emissivity setting of the pyrometer has to be adjusted accordingly.

Emissivity settings between 5% and 100% can be established through the InfraWin software or by using the UPP Data Format commands.

Measuring object	Emissivity [%] (at 2.3 $\mu\text{m}$ )
"Black body furnace"	100
Extruded Aluminum	13
Brass	18
Brass oxidized (tarnished)	65 to 70
Copper	5
Copper, oxidized	70 to 80
Inconel	30
Inconel, oxidized	85
Oxidized Iron	85 to 90
Steel rolling scale	80 to 88

Measuring object	Emissivity [%] (at 2.3 $\mu\text{m}$ )
Steel, molten	20 to 30
Nickel	15 to 20
Titanium, non-oxidized	50
Titanium, oxidized	75 to 80
Molybdenum	10
Molybdenum, oxidized	75 to 80
Black Carbon	95
Graphite	80 to 90
Stoneware, glazed	60
Porcelain rough	80 to 90



**Note:** Emissivity  $\varepsilon$  can be set from 5% to 100% in steps of 0.1%.

## 4.4 Transmittance $\tau$

Transmittance is a parameter that can compensate for signal loss due to external windows etc. For example, if the emissivity of the material is 0.6 and the transmittance of an additional window is 0.9, then the product would be 0.54 which is well inside the allowed range.

The product of transmittance and emissivity ( $\tau \times \varepsilon$ ) must not be less than 5%.



**Note:** Transmittance  $\tau$  can be set from 5% to 100% in steps of 0.1%.

## 4.5 Response Time ( $t_{90}$ )

The response time  $t_{90}$  is the time interval for the analog output of the pyrometer to go from a low temperature value up to 90% of the temperature step to a high value when measuring an abrupt increase from said low to said high temperature.

The dynamic exposure time adjustment prolongs the exposure time at the lower range limit. With the InfraWin software and the UPP Data Format commands it is possible to configure the dynamic exposure time.

Dependency of the response time on the temperature value				
MB 10	Temperature value	60 °C	120 °C	150 °C
	$t_{90}$ min	2 ms	1 ms	0.5 ms
MB 13	Temperature value	100 °C	150 °C	200 °C
	$t_{90}$ min	2 ms	1 ms	0.5 ms
MB 18	Temperature value	200 °C	250 °C	300 °C
	$t_{90}$ min	4 ms	1 ms	0.5 ms

Independently of this, the pyrometer performs a measurement every 25  $\mu\text{s}$  and updates the analog output. Slower response times can be used to achieve a constant temperature reading for measuring objects that have rapidly fluctuating temperatures.

The response time is set using the InfraWin software or by using the UPP Data Format commands. When the setting is set to min., the IGA 6/23 Advanced operates using a time constant of approximately 0.5 ms. The response time can be extended to 1 ms; 3 ms; 5 ms; 10 ms; 50 ms; 250 ms; 1 s; 3 s; 10 s.



**Note:** Settings for Response Time  $t_{90}$  min, 1 ms; 3 ms; 5 ms; 10 ms; 50 ms; 250 ms; 1 s; 3 s; 10 s

## 4.6 Clear Peak Memory ( $t_{CLEAR}$ )

The integrated maximum value storage is activated when the parameter  $t_{clear}$  is set to something other than "OFF" or "HOLD".

If the maximum value storage is switched on, the highest last temperature value will always be displayed and stored. As such, it may be beneficial to periodically clear and reset the stored maximum values in order to obtain new temperature readings.

This storage also has to be cleared at regular intervals when fluctuating object temperatures cause the display or the analog outputs to change too rapidly or when the pyrometer is not constantly viewing an object to be measured.

### Settings:

off  
10 ms  
50 ms  
250ms  
1 s  
5 s  
25 s  
extern  
auto

### 4.6.1 Single and Double Storage Modes

Depending upon the selected settings, the maximum value storage will either work in single storage mode or in double storage mode.

**Single Storage Mode:** Single storage mode is used when you want to reset the stored value using an external impulse via one contact closure from an external relay (such as between two measured objects). The relay contact is connected directly to the pyrometer between pins J and K. This mode allows a new value to be established after each impulse from the reset signal. Single storage mode also comes into effect when the Clear Peak Memory  $t_{clear}$  is set to AUTO.

**Double Storage Mode:** Double storage mode comes into effect when selecting one of the reset intervals. This mode utilizes two memories. With the first memory, the highest measured value is held and is deleted alternately in the time interval set (clear time). The other memory retains the maximum value throughout the next time interval. The disadvantages of fluctuations in the display with the clock frequency are thereby eliminated.



**Note:** The maximum value storage setting coincides with adjustments made to the response time.

The response time setting (working like a low-pass filter) is applied first. After that, the maximum storage is processed. So when using both, the maximum storage takes the peak of the signal that was previously smoothed by the response time filter.

## 4.6.2 Clear Time Settings

The following settings are available through the InfraWin software or by using the UPP data format commands.

- OFF** When set to **OFF**, the maximum value storage is switched off and all new temperature values are measured but not stored.
- 10 ms...25,0 s** If the clear time is set between **10 ms and 25.0 s**, the maximum value is held in double storage mode. After the entered time, the value will be cleared alternately from one of the storages, while the value of the other storage is shown.
- EXTERN** With the external clearing function, the storage operates in single storage mode. The values are immediately cleared from the storage by contacting the wires connected to pins J and K, if the **EXTERN** mode was selected.
- AUTO** The **AUTO** mode is used for discontinuous measuring tasks. For example, when objects are being transported on a conveyer belt and pass the measuring beam of the pyrometer only for a few seconds. In this case, the maximum value for each object has to be obtained.
- With the **AUTO** mode, the maximum value is stored until a new hot object appears in the measuring beam. The temperature, which has to be recognized as "hot" is defined by the low limit of the adjusted sub range.
- The stored maximum value will be deleted once the temperature of the new hot object exceeds the low limit of the sub range by 1% (transition in positive direction) or by at least 2 °C. This is also valid if the sub range equals the basic range.
- HOLD** The **HOLD** function allows you to freeze the current temperature reading at any moment. This feature is activated using an external switch that has been connected between connector pins J and K.
- The temperature reading will remain frozen as long as the contact remains closed.

## 4.7 Analog Output

The analog output has to be selected according to the signal input of the connected instrument (controller, PLC, etc.). If 4 to 20 mA is set, the analog output gives 3.9 mA for temperatures below lower range limit.

<b>Einstellungen:</b> 0 ... 20 mA 4 ... 20 mA
---



**Note:** Settings for Analog Output: 0 to 20 mA or 4 to 20 mA

0 to 20 mA/21 Low or 4 to 20 mA/21 Low (setting /21 Low = Analog Out shows 21 mA if signal intensity falls below Switch-Off level).

## 4.8 Sub Range

You have the opportunity to choose a sub range (minimum span 50 °C) within the basic measuring range of the pyrometer. This sub range corresponds to the analog output.

Example: Range 150...1800 °C, Sub Range 925...975 °C.

The sub range setting also affects the maximum value storage when the Clear Peak Memory  $t_{clear}$  is set to AUTO. For more information on the  $t_{clear}$  AUTO setting, refer to section [4.6](#).



**Note:** Settings for Sub Range - any range adjustable within the temperature range with a minimum span of 50 °C.

## 4.9 Device Address

When connecting several pyrometers to one serial interface with RS485, it is necessary for each instrument to have its own device address for communication purposes. First, it is necessary to connect each instrument separately to give it an address. After that, all instruments can be connected and addressed individually.

Settings:
00
⋮
97



**Note:** Only via own communication program with interface command (not possible with InfraWin, because InfraWin automatically detects a connected pyrometer): If parameters should be changed simultaneously on all pyrometers, the global **Address 98** can be used. This allows you to program all pyrometers at the same time, regardless of the addresses that have already been assigned. If the address of a pyrometer is unknown, it is possible to communicate with it using the global **Address 99** (connect only one pyrometer).

## 4.10 Focused Distance

The focused distance value can be adjusted at all distances between 210 mm and 5000 mm using the Focus Adjustment Screw on the back of the device.

The LED Distance Indicator Light will turn red and the focused measuring distance in mm will automatically be shown on the Digital Display within a few seconds of making an adjustment using the Focus Adjustment Set Screw.

The focused distance can be viewed at any time through the InfraWin software or by using the UPP Data Format commands.



## 4.11 Baud Rate

The transmission rate of the serial interface in Baud (Bd) is dependent on the length of the cable. A maximum cable length for 19200 Bd with RS485 is 2 km. The baud rate is reduced by 50% if the transmission distance is doubled.

Baud Rates can be set at 1200, 2400, 4800, 9600, 19200, 38400, 57600, or 115200.

## 4.12 Pyrometer Internal Temperature

The internal temperature of the pyrometer can be read through the PC interface using the InfraWin software or by using the UPP Data format commands. It is a few degrees higher than the ambient temperature due to the heat generated by the electronics.



When using the Laser Targeting Light, the targeting light is switched off automatically if the internal temperature of the pyrometer exceeds 61 °C. This safety feature is used to prevent damage to the laser. It can only be used again once the temperature falls below 61 °C.

## 4.13 Ambient Temperature Compensation

The compensation of the ambient temperature can be set for temperatures within the basic measuring range. This compensation is only used for very few special applications. The standard setting of this parameter is "auto", because the temperature of the air around the pyrometer is normally the ambient temperature of the measured object. Should the measured object be placed in an area with a higher wall temperature (e.g. inside a furnace), the measurement might be falsified (probably too high temperature indication). This influence can be compensated by presetting the ambient temperature of the object (presetting within the measuring range of the instrument). After switching over to "man" the corresponding data field  $T_{amb}$  is activated so that the ambient temperature value can be entered.

<u>Settings:</u> auto 00 °C (32 °F) ⋮ 70 °C (158 °F)
--



**Attention:** It has to be considered that this method only improves the results if the ambient temperature at the place of the measured object is always constant and the emissivity is well known.

---

## 5 Software InfraWin

The operating and analyzing *InfraWin* software is included with delivery of the pyrometer. In addition to allowing you to make parameter adjustments via PC, the *InfraWin* software also provides temperature indication, data logging, and measurement analysis features.

A software description can be found in the program's help menu. Click on the F1 button after loading *InfraWin* or click on the ? in the menu bar.

The latest version is available for free as download from the homepage [www.lumasenseinc.com](http://www.lumasenseinc.com).

### 5.1 Connecting the pyrometer to a PC

The program *InfraWin* can operate up to two devices. Two devices using RS485 may be operated simultaneously by the same interface, if two different addresses have been properly entered (see section 4.9 **Device Address** for more information).

### 5.2 Installation

To install the *InfraWin* software, select setup.exe from the *InfraWin*-CD or from the downloaded and unpacked zip file from the internet and then follow the installation instructions.

### 5.3 Program start

The first time you load *InfraWin* 5, you will be prompted to select a default language. The *InfraWin* software is available in German, English, Spanish, French, Portuguese, and Chinese. Once installed, click **Language/Languages** if you would like to select another language.

To ensure consistent document formatting, this page was intentionally left blank.

---

# 6 Maintenance

## 6.1 Cleaning the front window

Since the device does not contain parts that require regular maintenance, the only regular maintenance required is periodic inspection of the front window for build-up of foreign particiles. If allowed to build up, the particles can influence the energy received by the instrument.

The IGA 6/23 Advanced window is not water soluble and can be cleaned with standard lens tissue dampened with a commercially available glasses or camera lens cleaning solution. Use a soft blower/brush (available in camera stores) to remove any grit on the window before you rub the lens with lens tissue and solution.



**Attention: NEVER CLEAN THE IGA 6/23 Advanced WINDOW WITH A DRY TISSUE OF ANY KIND!** The only time dry lens tissue may be used is to dry a window which has already been cleaned with wet lens tissue.

---

## 6.2 Calibration

LumaSense calibrated your IGA 6/23 Advanced pyrometer at the factory and delivered your instrument with a Works Certificate. Normally we advise against changing the factory set calibration. If you believe that the calibration may have changed, perhaps because your operating environment is severe, an approximate field (on-site) calibration is possible. You have the choice of an on-site calibration or arranging a more precise calibration at the LumaSense factory.



**Note:** The calibration / adjustment of the instruments was carried out in accordance with VDI/VDE directive "Temperature measurement in industry, Radiation thermometry, Calibration of radiation thermometers", VDI/VDE 3511, Part 4.4. For additional details on this directive, see <http://info.lumasenseinc.com/calibration> or order the directive from "Beuth Verlag GmbH" in D-10772 Berlin, Germany.

---

### 6.2.1 Laboratory Calibration

Contact LumaSense for information about calibration at the LumaSense factory. For most of our customers who do not have large numbers of infrared thermometers in service, we recommend that our laboratory be chosen to do calibration. When you have many infrared thermometers, you may find it most convenient and economical to have your own calibration laboratory. LumaSense has a variety of blackbody calibration sources including very economical ones. Among these you may find the source most suitable for your own laboratory.

### 6.2.2 On-Site Calibration

See Chapter 9 Troubleshooting before attempting to perform your own calibration. The instrument was calibrated at the factory to its original accuracy as stated.

Nearly all erroneous temperature readings are caused by application problems such as:

- **Reflections:** Unexpectedly high readings may be caused by the IGA 6/23 Advanced “seeing” a reflection of another hotter source, especially if the target emissivity is less than 0.8.
- **Spot Sizes:** Ensure the IGA 6/23 Advanced is using a **proper focused distance** and takes into account the spot size in relation to measuring distance. The pyrometer can measure objects at any distance. However, the object has to be bigger than or at least as big as the spot size of the pyrometer in the measuring distance.
- **Obscured window:** Clean the window. Refer to the cleaning window section 6.1.

# 7 Data format UPP (Universal Pyrometer Protocol)

Software commands can be exchanged directly with the pyrometer through an interface using suitable communication software or by using the "Test" function located in the "Pyrometer Parameters" window of the InfraWin software package.

The data exchange occurs in ASCII format with the following transmission parameters:

- The data format is: 8 data bits, 1 stop bit, even parity (8,1,e) no handshake;
- The device responds to the entry of a command with output (such as the measuring value) + CR (Carriage Return, ASCII 13), to pure entry commands with "ok" + CR, or "no" + CR.
- Every command starts with the 2-digit device address AA followed by two lower case command letters and finished with CR.

**Example Read Command:** Entry: "00em" + <CR>

The emissivity setting ( $\epsilon$ ) of the device with the address 00 is returned.

Answer: "0970" + <CR> means Emissivity = 0.97 or 97.0%

- The ASCII parameter "X" indicates a change to be made in a parameter. When used, the command contains the new value.

**Example Write Command:** Entry: "00emXXXX" + <CR>

The parameter used for the emissivity setting ( $\epsilon$ ) with the address 00 is changed.

Answer: "00em0853" + <CR> changes the Emissivity to 0.853 or 85.3%

- A "?" after the lower case command letters answers with the limits of the respective settings (only at setting commands, not at query commands).

**Example Read Limits Command:** Entry: "00em?" + ~CR!

Answer: Could be 00501000 + <CR>, which means that E can vary between 0.050 and 1.000 (or 5% and 100%)

Description	Command	Parameters
Analog Output	AAasX	X=0 (0 to 20 mA)      X=1 (4 to 20 mA)
Reference Number	AAbn	Output: XXXXXX (hex 6-digit)
Baud rate (set)	AAbrX	X = 0 to 6 or 8 (dec.) 0 = 1200 Baud    1 = 2400 Baud    2 = 4800 Baud 3 = 9600 Baud    4 = 19200 Baud    5 = 38400 Baud 6 = 57600 Baud    7 = is not allowed    8 = 115200 Baud
Emissivity $\epsilon$	AAemXXXX AAem	XXXX = 0050 to 1000 $\epsilon$ =0.050 to 1.000 Answer: DDDD      4 decimal digits 0050 to 1000



Description	Command	Parameters
Sub range (read)	AAme	Answer: XXXXYYYY 2x4 hex-digit for lower and upper range limit (°C or °F)
Sub range (set)	1. AAm1XXXXYYYY	XXXXYYYY=2x4 hex-digit for lower and upper sub range limit (°C or °F)
	2. AAm2	AAm2 confirms the change (auto reset)
Measuring value	AAms	Answer: QQQQ (88880=Overflow) 5 decimal digit (in °C or °F, last digit is 1/10 °C or °F)
Device type	AAna	Output: "IGA 6/23 Advanced" (16 ASCII-characters)
Read Parameters	Aapa	Answer: 15 decimal digits DD. . . . . : Emissivity (see em) . . D. . . . . : Response time (see ez) . . . D. . . . . : Clear peak memory (see lz) . . . . D. . . . . : Analog output (see as) . . . . . DD. . . . . : Internal temperature (see gt) . . . . . DD. . . . . : Device address (see ga) . . . . . D. . . . . : Baud rate (see br ) . . . . . 01000 : Fixed value
Serial number	AAsn	Output: XXXXX (hex 5-digit)
Device type / Software version	AAve	Answer: VVMMJJ VV=27 MM=Month JJ = Year of software version
Communication Module/ software version in detail	AAvc	tt.mm.jj XX.YY tt = day; mm = month; jj = year; XX.YY = Software version
Software version in detail	AAvs	tt.mm.jj XX.YY tt = day; mm = month; jj = year; XX.YY = Software version

Note: the letter "l" means the lower case letter of "L".

**Additional instruction for the RS485 interface:**

Requirements to the master system during half-duplex operation:

1. After an inquiry, the bus should be switched into a transmission time of 3 bits (some older interfaces are not fast enough for this).
2. The pyrometer's response will follow after 5 ms, at the latest.
3. If there is no response, there is a parity or syntax error and the inquiry has to be repeated.
4. After receiving the response, the master has to wait at least 1.5 ms before a new command can be entered.

To ensure consistent document formatting, this page was intentionally left blank.

# 8 Reference Numbers

## 8.1 Reference numbers instrument

Temperature Range	With Laser Targeting		With Viewfinder	
	RS485	RS232	RS485	RS232
50 to 1000 °C (MB 10)	3 914 210	3 914 330	3 914 220	3 914 340
75 to 1300 °C (MB 13)	3 914 250	3 914 370	3 914 260	3 914 380
150 to 1800 °C (MB 18)	3 914 290	3 914 410	3 914 300	3 914 420

### Ordering note:

A connection cable is not included in scope of delivery and has to be ordered separately.

## 8.2 Reference numbers accessories

- 3 820 320 Special connection cable with angled connector and additional targeting light push button, 5 m long
  
- 3 820 330 Connection cable, 5 m, with straight connector
- 3 820 500 Connection cable, 10 m, with straight connector
- 3 820 510 Connection cable, 15 m, with straight connector
- 3 820 810 Connection cable, 20 m, with straight connector
- 3 820 820 Connection cable, 25 m, with straight connector
- 3 820 520 Connection cable, 30 m, with straight connector
  
- 3 820 340 Connection cable, 5 m, with right angle connector
- 3 820 530 Connection cable, 10 m, with right angle connector
- 3 820 540 Connection cable, 15 m, with right angle connector
- 3 820 830 Connection cable, 20 m, with right angle connector
- 3 820 840 Connection cable, 25 m, with right angle connector
- 3 820 550 Connection cable, 30 m, with right angle connector
  
- 3 852 290 Power supply NG DC for DIN rail mounting; 100 to 240 V AC ⇒ 24 V DC, 1 A
  
- 3 852 550 Power supply NG 2D for DIN rail mounting; 85 to 265 V AC ⇒ 24 V DC, 600 mA with two settable limit switches
  
- 3 826 750 USB to RS485 adapter cable, HS-Version, 1.8 m long
  
- 3 852 440 Protocol transducer RS485/RS232 (switch.) <-> Profibus-DP for 1 device
  
- 3 852 460 Protocol transducer RS485 <-> Profibus DP for 32 devices
  
- 3 852 620 Protocol converter UPP RS485 or RS232 <-> ProfiNet, for 1 pyrometer
  
- 3 852 630 Protocol converter UPP RS485 <-> ProfiNet, for max. 32 pyrometers

(All connection cables include a short adapter cable with a 9-pin D-SUB connector. This connector may be used in combination with the RS485 to USB adapter.)

- 3 891 220 DA 4000: LED-display, 2-wire power supply, 2 limit switches (relay contacts), 115 V AC
- 3 890 650 DA 4000: LED-display, 2-wire power supply, 2 limit switches (relay contacts), 230 V AC
- 3 890 570 DA 6000-N digital display to allow adjustment of the Pyrometer through the RS485 interface
- 3 890 530 DA 6000: like DA 6000-N with analog input and 2 limit switches for the RS485 interface
- 3 826 510 PI 6000: PID programmable controller, very fast, for digital IMPAC pyrometers
- 3 890 630 LD24-UTP; large digital indicator, 57 mm height of digits
- 3 843 490 SCA 5, External Scanner Series 5 & 6 with fused silica window, 24 V AC/DC
- 3 846 260 Instrument's support (Series 5 & 6)
- 3 834 210 Adjustable mounting support (Series 5 & 6)
- 3 846 290 Instrument's support (Series' 5 & 6) with fused silica window
- 3 835 590 90° mirror for Series 5 and Series 6, quartz glass window
- 3 843 250 ROT5 scanning mirror attachment up to 70°
- 3 843 430 Scanning mirror attachment up to 12°
- 3 835 160 Air purge unit, aluminum
- 3 837 230 Water cooling jacket (heavy duty) with integrated air purge
- 3 837 280 Water cooling jacket (heavy duty) with fused silica window
- 3 837 500 Water cooling jacket (light duty, with air purge unit (only for instruments with laser targeting)
- 3 837 510 Water cooling jacket (light duty), with fused silica window (only for instruments with laser targeting)
- 3 837 540 Cooling plate for series 5 and 6, with air purge
- 3 846 590 Vacuum support KF16 with quartz glass window

## 9 Troubleshooting

Symptom	Probable Cause	Comments
No analog output even if the display shows a temperature above lower range limit	Reversed leads to IGA 6/23 Advanced	The IGA 6/23 Advanced is diode protected if power leads are reversed  See section <a href="#">3.1</a>
	Reversed leads to other instruments in the current loop	
	Open circuit in lines connecting all instruments in current loop	
	Total burden higher than 500 Ohms	
	Insufficient supply voltage (See wiring diagram)	
Temperature reading differs between built-in display and external instrumentation	Pyrometer output setting differs from external instrument's input setting	Check the 0 to 20 mA or 4 to 20 mA on both sides  Check the sub range setting on pyrometer against the range setting on the external instrument
Temperature readings are too low	Target size too small	See section <a href="#">3.2</a>  With small target/close focus models, aiming may require X-Y positioning table for fine adjustment during aiming
	Target is not at correct focus distance	
	Incorrect alignment of the pyrometer to the object	Realign pyrometer to achieve the maximum temperature signal
	Dirty window or lens	See Section <a href="#">6.1</a>
	Target temperature too low	
	Incorrect slope adjustments	
	Faulty IGA 6/23 Advanced	Contact LumaSense. See section <a href="#">1.5</a>
Temperature readings are too high	Targets hotter than expected. (This often happens with first time infrared Pyrometer users)	Verify target temperature with contact type method  (Thermocouples may not accurately determine surface temperature due to "heat sink" effect)
	The measurement is influenced by reflections of hot machine parts	Use mechanical accessories to avoid the influence of the interfering radiation

Symptom	Probable Cause	Comments
Temperature readings are too high	If target emissivity is less than 1, reflections from nearby hot objects will influence readings	Block reflection paths to see if readings drop to expected temperature
	Incorrect spectral response for application. IGA 6/23 Advanced may be "seeing" through target	See Technical Specifications Consult LumaSense for analysis
	Faulty IGA 6/23 Advanced	Contact LumaSense. See section <a href="#">1.5</a>
	Electrical noise in lead wires caused by intense magnetic fields and/or improper selection of interconnecting cable and/or cable run in same conduit as AC power lines	See section <a href="#">3.1</a>
	Lens or window clouding up	Increase or decrease air purge rate and/or investigate other cause
	Improper grounding of cable shield and/or IGA 6/23 Advanced housing (or cooling jacket)	
	IGA 6/23 Advanced mounting not secure	
Noisy readings (fast fluctuations)	Target moves more than 95% out of field of view. Conveyor type applications will also cause fluctuations as targets move by the field of view	Application may require Maximum to be stored. Apply $t_{clear}$ settings. See section <a href="#">4.6</a>
	Target may be changing temperature quickly. (Thermocouples do not respond as fast as the IGA 6/23 Advanced)	Speed of response may be slowed down Apply $t_{90}$ settings. See section <a href="#">4.5</a>
	Target may be reflecting nearby objects that have fluctuating temperatures	
	Loose connection in wiring	
	Electrical noise lead wires caused by intense magnetic fields, improper selection of inter-connecting cable	
	Cable run into in same conduit as AC power lines	
	Flame or reflections of flame may be entering the field of view	

Symptom	Probable Cause	Comments
Noisy readings (fast fluctuations)	Extremely dense steam, smoke, thick dust, personnel or moving machinery intermittently blocking 95% of optical path of IGA 6/23 Advanced	
	Non-uniform emissivity of large moving targets	Slower response speed is required
	Faulty IGA 6/23 Advanced	Contact LumaSense. See section <a href="#">1.5</a>
Laser Targeting Light fails	The instrument's internal temperature is higher than 61 °C	Use cooling jacket



**Note:** The wavelength band of the IGA 6/23 reacts at low measuring temperatures (below 130 °C) to incandescent lamps or very bright daylight (not valid for fluorescent tube). For a correct measurement strong external light to the measured object should be avoided.

---

To ensure consistent document formatting, this page was intentionally left blank.

---

# Index

## A

Accessories 12  
Air Purge 12  
Analog Output 28  
Aperture 21  
Appropriate use 9

## B

Baud Rate 29

## C

Calibration 33  
    Laboratory 33  
    On-Site 34  
Cleaning the front window 33  
Clear Peak Memory 27  
Clear Time Settings 28  
Connecting the pyrometer to a PC 17  
Connection cable 9  
Connection of Additional Units 18  
Connection to RS485 17  
Cooling Jacket 12

## D

Data format UPP 35  
Device Address 29  
Device Settings  
    Clear Peak Memory tclear 27  
Dimensions 11  
Disposal 7  
Double Storage Mode 27

## E

Electrical Installation 15  
Electromagnetic requirements 15  
Emissivity 25

## F

Focus Adjustment Screw 22, 29  
Focused Distance 29

## G

General Information 5

## I

Installation, Electrical 15

## L

Laboratory Calibration 33  
Language 31  
Laser Targeting Light 19  
LED Distance Indicator Light 22  
Legend 5  
Liability 6

## M

Maintenance 33  
Measuring distance 22  
Measuring Distance 21  
Mounting 12

## O

On-Site Calibration 34  
Optics 20

## P

Physical User Interface 11  
Pin assignment 16  
Pyrometer Internal Temperature 30  
Pyrometer parameters 25

## R

Reference numbers  
    Accessories 39  
    Instrument 39  
Reference Numbers 39  
Repair 6, 7  
Response Time 26  
RS485 17

## **S**

- Safety 5
- Scope of delivery 9
- Service Request 6
- Settings / parameter descriptions 25
- Sighting 18
- Single Storage Mode 27
- Software InfraWin 31
- Spot Sizes 20, 21
- Spot sizes for non-focused distances 21
- Storage Modes 27
- Sub Range 28
- Support 6

## **T**

- Technical Data 9
- Temperature Display 25
- Transmittance 26
- Troubleshooting 41

## **U**

- Unpacking the Instrument 6
- UPP data format 35

## **V**

- Vacuum Pickup 12
- Viewfinder 18

## **W**

- Warranty 6